



+91-8046041504

# Vide Energy

<https://www.indiamart.com/vide-energy/>

Established in the year 2015, we “Vide Energy” are a prominent firm that is engaged in manufacturing a wide range of Solar Power Plants, Solar Rooftop System, Solar Mounting Structure, Solar Mounting Purlins, etc.

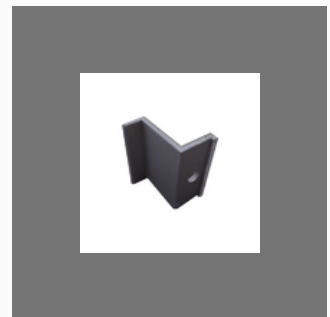
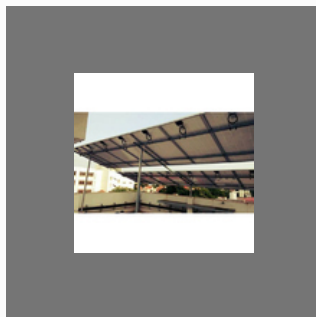
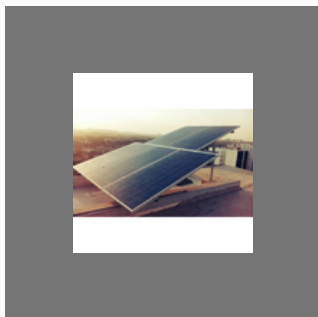

## About Us

Established in the year **2015**, we “**Vide Energy**” are a prominent firm that is engaged in **manufacturing** a wide range of **Solar Power Plants, Solar Rooftop System, Solar Mounting Structure, Solar Mounting Purlins**, etc. Apart from this, we also provide **Installation Service** of our own products. Located in **Ahmedabad (Gujarat, India)**, we are **Partnership** firm and manufacture the offered products as per the set industry norms. Our valued clients can avail these products from us at reasonable rates. Under the headship of “**Mr. Dipen Patel**” (**Partner**), we have gained a remarkable and strong position in the market.

**For more information, please visit**

<https://www.indiamart.com/vide-energy/profile.html>



# SOLAR ROOFTOP SYSTEM

Our Product Range



Home Solar Rooftop System



5 KW Solar Rooftop System



Industrial Solar Power Rooftop Systems

# SOLAR MOUNTING STRUCTURE

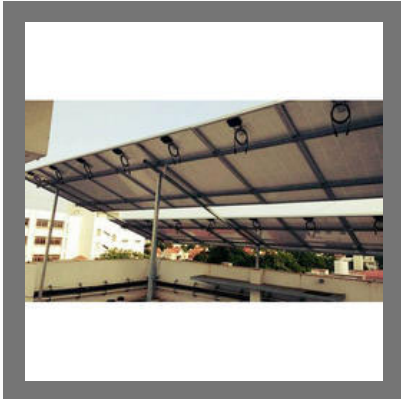

Solar Panel Mounting Structure

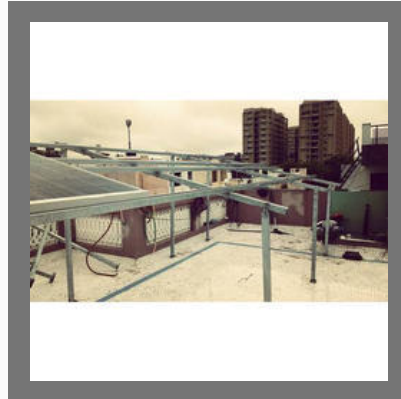

Solar Module Mounting Structure



Solar Frame Mounting Structure

## OTHER PRODUCTS:

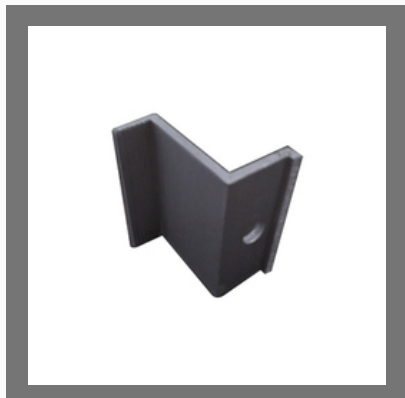

End Clamps



Solar MID Clamp



STRUT CHANNEL



Solar Purlins

## OTHER PRODUCTS:



AC Distribution Box

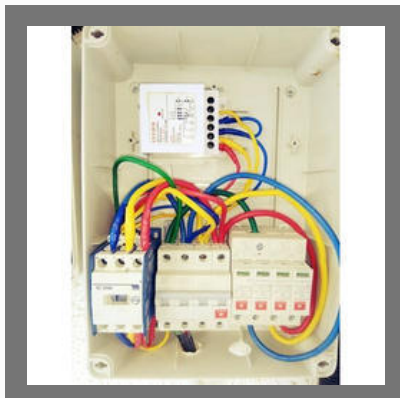

DC Distribution Box



SLOTTED CHANNEL

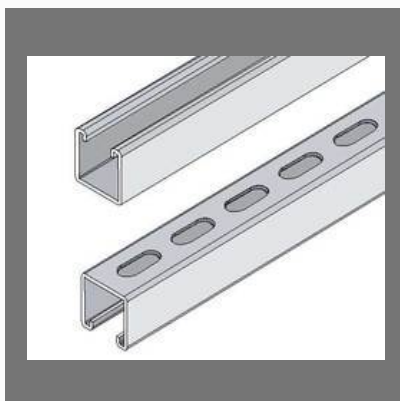

PURLINE

# Factsheet

Year of Establishment : 2015

---

Nature of Business : Manufacturer

---

Total Number of Employees : Upto 10 People

---



## CONTACT US

### **Vide Energy**

Contact Person: Dipen Patel

REVABHAI INDUSTRIAL ESTATE, 19/B, CTM, CTM.MILL CHAR RASTA,  
Ahmedabad - 380026, Gujarat, India



+91-8046041504



<https://www.indiamart.com/vide-energy/>